

35 Series Service Case Single Duty - Hot Food Case



Model No.	Description	Length	Depth	Height	Voltage	Amps	Power Cord	Est. Ship Weight
CHS35-4	3 Wells	50"	35.5"	52"	120/240/3	4.4/11.6	NO	480
CHS35-6	4 Wells	71"	35.5"	52"	120/240/3	5.8/17.6	NO	625
CHS35-8	6 Wells	95"	35.5"	52"	120/240/3	8.7/23.1	NO	880

MODEL NUMBER PREFIX - SC = Self-contained R = Remote
 MODEL NUMBER SUFFIX - W = White B = Black S = Stainless Steel
 • Cases are designed to operate at 75 degrees Fahrenheit and 55% relative humidity
 • Cases are equipped with drains; check your local building codes for connection requirements.
 • Specification subject to change without notice
 IF COLORS ARE MIXED AN ADDITIONAL CHARGE WILL APPLY



35 Series Service Case Single Duty - Hot Food Case

Standard Specifications and Optional Features

CONSTRUCTION

- Foamed in place CFC free foam
- Single pane tempered front safety glass
- Heavy gauge steel super structure
- ETL listed for safety and sanitation

INTERIOR

- White, black or stainless steel ends
- Stainless steel deck area around wells (for easy cleaning)
- Wet or dry heated individual wells
- Individual thermostatically controlled wells
- Separate drain for each well
- Flood lamp over each well

EXTERIOR

- White, black or stainless steel exterior
- Double pane rear removable doors
- Newly designed rear compression door jamb
- Heavy duty bright stainless steel top
- Vented front minimizes moisture on glass
- 1" front bumper

FINISHES

- White, black or stainless steel front and ends
- Stainless steel mirror trim
- Stainless steel heavy gauge top - 17.375" W
- White, black or stainless steel exterior rear

LIGHTING

- Individual heat lamps over each well - 175W each

Important Note:

All cases are designed to operate in an environment of 75 degrees and 55% relative humidity.

DRAIN IS REQUIRED

Electrical Requirements

Model No.	Wells	Volts	Phase	AMPS
CHS35-4-LED	3	120V/208V	1	4.4A/17.3A
		120V/240V	1	4.4A/20.0A
		120V/208V	3	4.4A/10.0A
		120V/240V	3	4.4A/11.6A
CHS35-6-LED	4	120V/208V	1	5.8A/23.1A
		120V/240V	1	5.8A/26.7A
		120V/208V	3	5.8A/15.3A
		120V/240V	3	5.8A/17.6A
CHS35-8-LED	6	120V/208V	1	8.7A/34.6A
		120V/240V	1	8.7A/40.0A
		120V/208V	3	8.7A/20.0A
		120V/240V	3	8.7A/23.1A

35 Series Service Case Single Duty - Hot Food Case

Technical Data

Model No.	CHS35-4	CHS35-6	CHS35-8
Length	50"	71"	95"
Height	52"	52"	52"
Depth	35.5"	35.5"	35.5"
# of wells	3	4	6
(Dimensions are +/- 1/4")			
Voltage - standard	120/240	120/240	120/240
Phase	3	3	3
Amperage	4.4/11.6	5.8/17.6	8.7/23.1
Voltage - optional	120/240	120/240	120/240
Phase	1	1	1
Amperage	4.4/20	5.8/26.7	8.7/40
Voltage - optional	120/208	120/208	120/208
Phase	3	3	3
Amperage	3.8/10	5.8/15.3	8.7/20
Voltage - optional	120/208	120/208	120/208
Phase	1	1	1
Amperage	4.4/17.3	5.8/23.1	7.5/34.6
Exterior color	W, B, S	W, B, S	W, B, S
Interior color	W, B, S	W, B, S	W, B, S
Floors	W, B, S	W, B, S	W, B, S
# of top rear doors	2	2	4
Front viewing area	21"	21"	21"
Bottom Storage	NO	NO	NO
Door size	19.56" x 19.25"	29.81" x 19.25"	19.56" x 19.25"
Shipping Info			
Height	58"	58"	58"
Depth	44"	44"	44"
Length	61"	87"	109"
Gross weight	450	595	850
Cubic feet	90	128	164

(ALL WHITE OR ALL BLACK, NO EXTRA CHARGE—IF COLORS ARE MIXED AN ADDITIONAL CHARGE WILL APPLY)

Prefix

SC = Self-contained
R = Remote

Suffix

B = Black
W = White
S = Stainless Steel

- Cases are designed to operate at 75 degrees Fahrenheit and 55% relative humidity
- Cases are equipped with drains; check your local building codes for connection requirements.
- Specification subject to change without notice

Technical Data Views

4 Wells

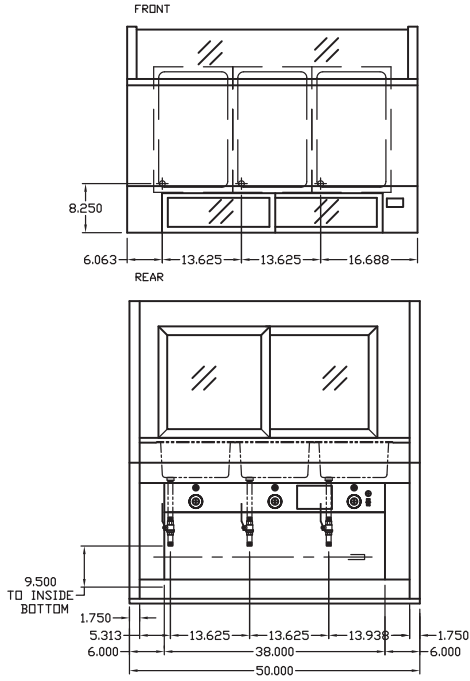

35 Series Service Case Single Duty - Hot Food Case

Cross Section

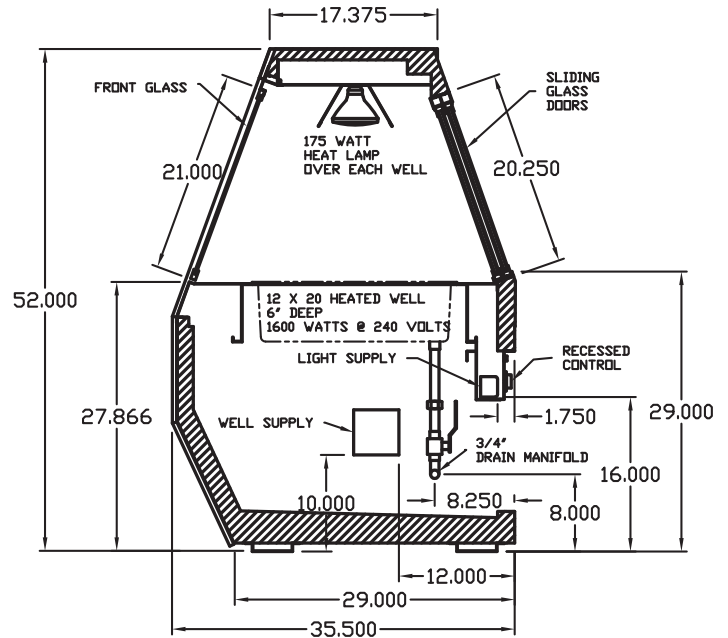

8 Wells

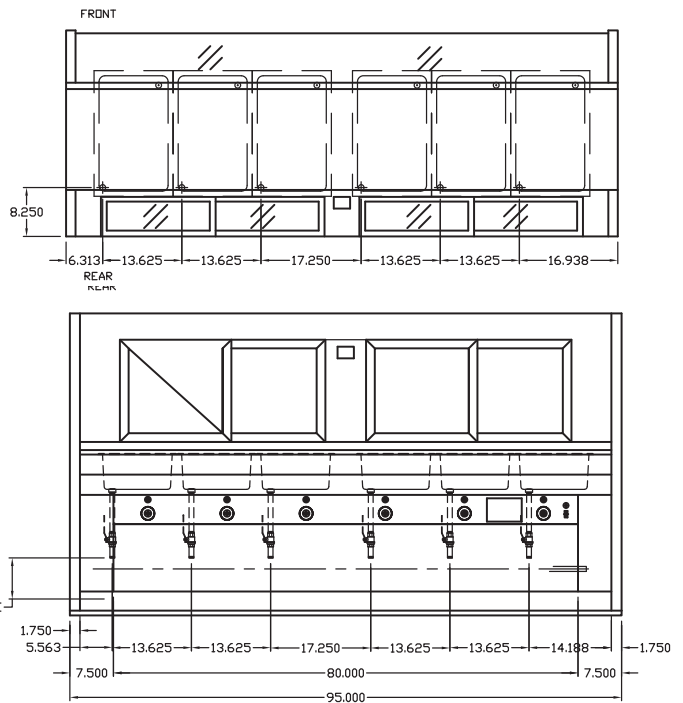

6 Wells

